

HLS27 Hazardous Location LED Strip Light

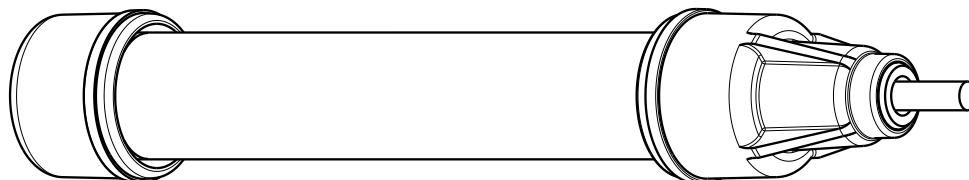

Datasheet

Banner's HLS27 Hazardous Location LED Strip Light has a sturdy aluminum housing and is encased in a shatterproof, UV-stabilized, polycarbonate shell, making it ideal for harsh indoor and outdoor applications.



- Low-profile, space-saving design for use in hazardous locations
- Rugged, water-resistant IEC IP66, IEC IP67 design
- Available in eight lengths from 145 mm to 1130 mm
- Available in single or dual color models
- Standard and optional 300 series stainless steel mounting brackets protect against impact
- Single color models have the capability to dim lights using the wiring pinout (Hi/Lo/Off)
- Pulse Width Modulation (PWM) models have the capability to control intensity from 0% to 100% using PWM on an input control wire
- Automatic temperature protection built into the unit—above 50 °C, the light dims to manage heat and protect product lifetime
- Certification for cULus and ATEX/IECEX, see details in specifications

Models — Single Color and PWM

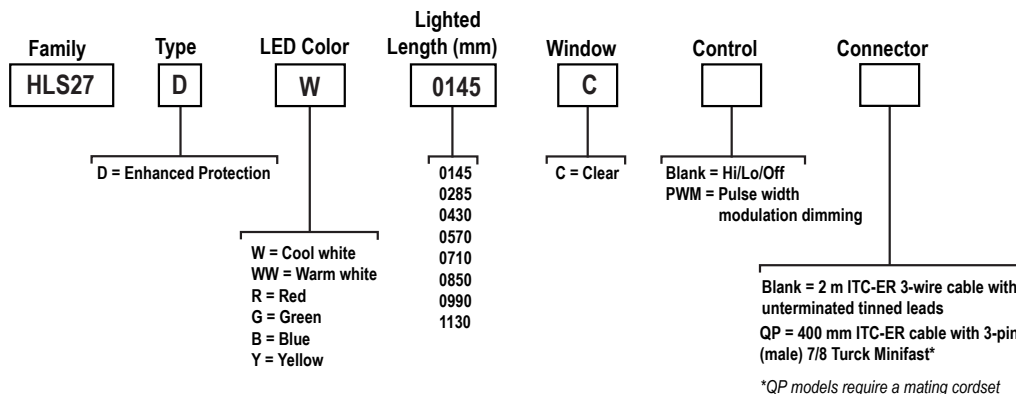

| Type | Protection | Suitable for ATEX / IECEx | | Suitable for NEC & CEC | |
|------|---------------------|--------------------------------|----------------------------|---|-----------------------------------|
| | | Models with Unterminated Leads | Models with Turck Minifast | Models with Unterminated Leads | Models with Turck Minifast |
| D | Enhanced Protection | Gas Zone: 2 Dust Zone: 22 | Gas Zone: 2 | Gas Zone: 2 Dust Zone: 22 Class I Division 2 Class II Division 2 Class III Division 1 and 2 | Gas Zone: 2 Class I Division 2 |



Important: QP models require a mating cordset and are not approved for use in locations where dust or fibers creates a hazard: Class II, Class III, and Zone 22. Select the 2.0 m unterminated cable option for locations where Class II, Class III, or Zone 22 certifications is required.



Models — Dual Color

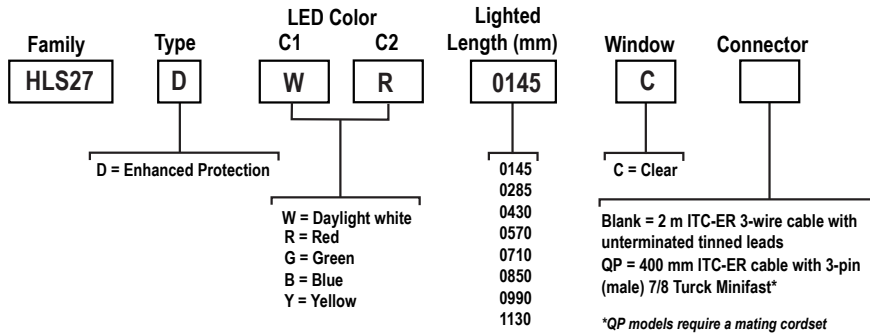

| Type | Protection | Suitable for ATEX / IECEx | | Suitable for NEC & CEC | |
|------|---------------------|--------------------------------|----------------------------|---|-----------------------------------|
| | | Models with Unterminated Leads | Models with Turck Minifast | Models with Unterminated Leads | Models with Turck Minifast |
| D | Enhanced Protection | Gas Zone: 2 Dust Zone: 22 | Gas Zone: 2 | Gas Zone: 2 Dust Zone: 22 Class I Division 2 Class II Division 2 Class III Division 1 and 2 | Gas Zone: 2 Class I Division 2 |



Important: QP models require a mating cordset and are not approved for use in locations where dust or fibers creates a hazard: Class II, Class III, and Zone 22. Select the 2.0 m unterminated cable option for locations where Class II, Class III, or Zone 22 certifications is required.

Installation Instructions

Hazardous Location Applications



WARNING:

- **Hazardous Locations**
- It is the user's responsibility to ensure that all local, state, and national laws, rules, codes, or regulations relating to the installation and use of this device in any particular application are satisfied. This device must be installed by Qualified Persons, in accordance with this document and applicable regulations.
- A Qualified Person is a person who, by possession of a recognized degree or certificate of professional training, or who, by extensive knowledge, training and experience, has successfully demonstrated the ability to solve problems relating to the subject matter and work.



WARNING: The hazardous location mounting hardware is designed to help protect the HLS27 light from damage during impact and must be used in all hazardous location applications. Failure to use the Banner supplied mounting hardware correctly will void the hazardous location rating of the light.



CAUTION:

- **Electrostatic Discharge (ESD) Special Conditions for Safe Use**
- Parts of the enclosure are non-conducting and can generate an ignition-capable level of ESD.
- Clean the equipment with only a damp cloth.

General Notes and Conditions for Safe Use:

- See Specifications and Wiring Diagrams for important information concerning entity parameters, permissible locations, electrical connections and certifications.
- In addition to the warning above concerning user responsibility, the installation must comply with the following:
 - All installations must comply with all manufacturer's instructions.
 - This device is provided with a PLTC-ER/ITC-ER cable and must be installed in accordance with the following:

- NEC Article 501.10 (B) for Class I Division 2
 - NEC Article 502.10 (B) for Class II Division 2
 - NEC Article 503.10 (A) or (B) for Class III Division 1 or 2 respectively
 - Canadian Electrical Code (CSA C22.1) for Canadian Installations
 - Section 9 of IEC 60079-14 for ATEX/IECEX locations
- The PLTC-ER/ITC-ER cable shall be installed in accordance with the provisions of NEC Article 725 (PLTC-ER) or 727.4 (ITC-ER) for Class I Division 2, Class II Division 2, and Class III Division 1 and 2 locations.
 - The 7/8 Turck Minifast connector must be used with a mating female 7/8 Minifast connector manufactured by Turck and certified for the appropriate location classification and installed following the requirements of Turck Control Drawing Ni-2.422. Examples of an appropriate mating connector are shown in [Accessories](#) on p. 9 and are available for purchase separately from Banner.
 - All connections in the hazardous location must be secured by a locking device. An example of appropriate locking device is shown in [Accessories](#) on p. 9. One locking device is provided with each model that is fitted with a Turck Minifast connector. Locking devices are also available for purchase separately from Banner.
 - The cable shall be terminated with a fitting certified for the appropriate location classification
 - The device must be powered by a suitable Class 2 power supply (UL) or a SELV power supply (CE)
- Do not attempt any repairs to this device; it contains no field-replaceable parts or components. Tampering and/or replacement with non-factory components may adversely affect the safe use of the system.
 - The nonconducting materials of this device may be susceptible to ignition-capable level of electrostatic charging and precautions must be taken to avoid this. The user/installer shall ensure that the equipment is not installed in a location where it may be subjected to external conditions (such as high-pressure steam) which are conducive to creating a build-up of electrostatic charges.
 - The user/installer must take suitable precautions to prevent the device from being adversely affected by aggressive substances, such as acidic liquids or gases that may attack metals, or solvents that may affect polymeric (plastic) materials. Suitable precautions include routine inspection or maintenance procedures require replacement of damaged devices or establishing from the materials data sheet that the device is resistant to specific chemicals. These precautions must ensure that the type of protection is not compromised.

Wiring Diagram

| Unterminated and 3-pin Male Mini | Pin | Wire Color | Single Color Models | Dual Color Models | PWM Models |
|----------------------------------|-----|------------|--|---|--|
| | 1 | blue (bu) | dc common | dc common | dc common |
| | 2 | brown (bn) | 12 V dc to 30 V dc | Color 1: 12 V dc to 30 V dc | 12 V dc to 30 V dc |
| | 3 | black (bk) | Connect to 12 V dc to 30 V dc for 50% intensity. For 100% intensity, leave the black wire floating or connected to common. | Color 2: 12 V dc to 30 V dc (color 2 overrides color 1) | Pulse width modulation (PWM) input. For maximum intensity, leave the black wire floating or connected to common. Connecting to 12 V dc to 30 V dc will cause LEDs to shut off. |

Mounting Instructions

Multiple mounting options are available for the HLS27 in hazardous locations. In the two options listed below, the mounting brackets must be spaced a distance of (L4) apart to ensure the device meets impact protection standards for hazardous locations.

Included Mounting Hardware (LMBHLS27S – 2 Brackets)

When using the standard mounting hardware, the mounting hole centers for each individual bracket must be spaced 50.0 mm (1.97 inches) from one another. This spacing is critical for the bracket to provide the required impact protection and prevent rotation of the light within the bracket.

The stainless-steel bracket is designed to be used with M5 or #10 stainless-steel hardware.

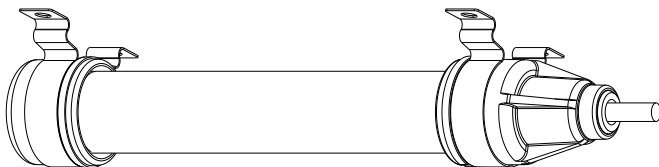
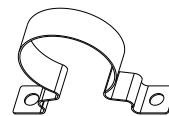

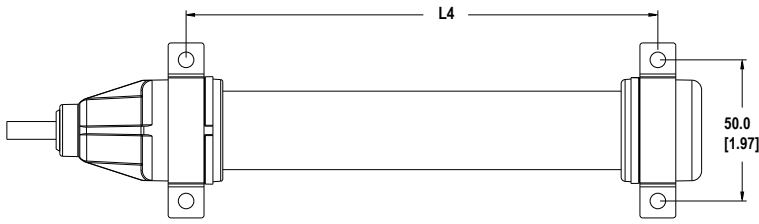

| Models | L4 |
|---------------|-------------------|
| HLS27..0145.. | 168 mm (6.6 in) |
| HLS27..0285.. | 309 mm (12.2 in) |
| HLS27..0430.. | 450 mm (17.7 in) |
| HLS27..0570.. | 591 mm (23.3 in) |
| HLS27..0710.. | 732 mm (28.8 in) |
| HLS27..0850.. | 873 mm (34.4 in) |
| HLS27..0990.. | 1014 mm (39.9 in) |
| HLS27..1130.. | 1155 mm (45.5 in) |

Optional Mounting Hardware (LMBHLS27O – 2 Brackets and Hardware) Purchased Separately

When using the optional mounting hardware, the head of the fastener used must not exceed 5.0 mm (0.2 inches) in height. Fasteners exceeding this height could damage the light housing during impact situations.

When using the optional mounting hardware, the supplied spacer must be used with the bolt to maintain the correct bracket shape. This shape is critical for the bracket to provide the required impact protection.

The stainless-steel bracket is designed to be used with M5 or #10 stainless-steel hardware.

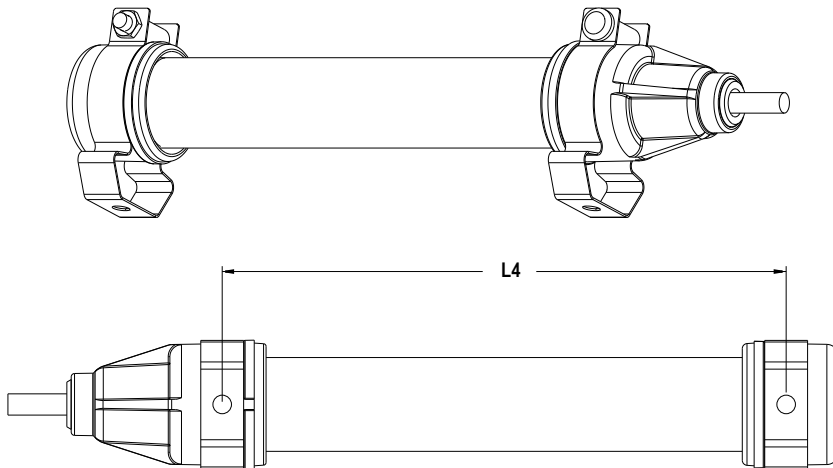
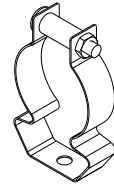

| Models | L4 |
|---------------|-------------------|
| HLS27..0145.. | 168 mm (6.6 in) |
| HLS27..0285.. | 309 mm (12.2 in) |
| HLS27..0430.. | 450 mm (17.7 in) |
| HLS27..0570.. | 591 mm (23.3 in) |
| HLS27..0710.. | 732 mm (28.8 in) |
| HLS27..0850.. | 873 mm (34.4 in) |
| HLS27..0990.. | 1014 mm (39.9 in) |
| HLS27..1130.. | 1155 mm (45.5 in) |

Light Anti-Rotation Pads

In applications where vibration is a concern or when light orientation is critical, use anti-rotation pads to prevent the light from rotating within the mounting brackets. Light rotation caused by vibration may be more pronounced with longer length lights.

Attach the anti-rotation pads to the brackets, as shown in the figures, with the adhesive side applied to the bracket.

Figure 1. Included Mounting Hardware with Anti-Rotation Pads 

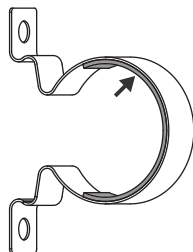

Note: When using the optional mounting hardware, cut the anti-rotation pad and apply it to both sides of the mounting bracket as shown.

Figure 2. Optional Mounting Hardware with Anti-Rotation Pads

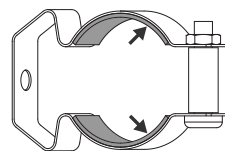

Specifications

Supply Voltage

12 V DC to 30 V DC
Use only with suitable Class 2 power supply (UL) or a SELV power supply (CE)

| Light Length | Typical Current | | | Max. Current |
|--------------|-----------------|---------|---------|--------------|
| | 12 V DC | 24 V DC | 30 V DC | A |
| 145 mm | 0.33 A | 0.15 A | 0.12 A | 0.4 |
| 285 mm | 0.66 A | 0.30 A | 0.24 A | 0.8 |
| 430 mm | 1.01 A | 0.46 A | 0.36 A | 1.2 |
| 570 mm | 1.36 A | 0.61 A | 0.48 A | 1.6 |
| 710 mm | 1.75 A | 0.77 A | 0.60 A | 2.0 |
| 850 mm | 2.13 A | 0.92 A | 0.73 A | 2.4 |
| 990 mm | 2.59 A | 1.08 A | 0.85 A | 2.8 |
| 1130 mm | 3.04 A | 1.24 A | 0.97 A | 3.2 |

Pulse Width Modulation (PWM Models Only)

Frequency: Up to 1000 Hz
Voltage: 8 V DC to 30 V DC
Current: 4 mA maximum per foot

Vibration and Mechanical Shock

Vibration: 10 Hz to 55 Hz, 1.0 mm peak-to-peak amplitude per IEC 60068-2-6
Shock: 15G 11 ms duration, half sine wave per IEC 60068-2-27

Connections

2 m long, 6.3 mm (0.25 inch) diameter ITC-ER cable with unterminated leads; pressured EX60 jacket (type ST2 per IEC 60092-360:2014), paper separator, filler as needed, compliant with 60332-3-22; UL TC-ERDB, ITC, PLTC, ERDB, IEEE 1580-2010, ABS; or a 400 mm ITC-ER cable with a 3-pin 7/8 Minifast-style male quick disconnect (QD)
Quick disconnect models (end in QP) require a mating cordset and are not approved for use in locations where dust or fibers creates a hazard: Class II, Class III, and Zone 22. Select the 2 m unterminated cable option for locations where Class II or Zone 22 certifications is required. Connections in the hazardous location must be secured by a locking device (provided with the product).

Construction

Clear anodized aluminum housing; UV stabilized polycarbonate outer housing

Supply Protection Circuitry

Protected against reverse polarity and transient voltages

LED Lifetime

Lumen Maintenance - L₇₀
When operating within specifications, output will decrease less than 30% after 50,000 hours

Mounting

Bracket kit LMBHLS27S included (2 brackets for use with HLS27 Hazardous Location LED Strip Light)
Optional bracket kit LMBHLS27O (2 brackets and hardware for use with HLS27 Hazardous Location LED Strip Light)

Operating Temperature

For NEC & CEC applications: -40 °C to +60 °C (-40 °F to +140 °F)
For ATEX/IECEX applications: -40 °C to +50 °C (-40 °F to +122 °F)
90% maximum relative humidity (non-condensing)
Light output begins to decrease above 50 °C (122 °F) and will be approximately 65% of maximum intensity of 60 °C (140 °F)
Storage Temperature: -40 °C to +70 °C (-40 °F to +158 °F)

Environmental Rating

IEC IP66, IEC IP67

Required Overcurrent Protection



WARNING: Electrical connections must be made by qualified personnel in accordance with local and national electrical codes and regulations.

Overcurrent protection is required to be provided by end product application per the supplied table.
Overcurrent protection may be provided with external fusing or via Current Limiting, Class 2 Power Supply.
Supply wiring leads < 24 AWG shall not be spliced.
For additional product support, go to www.bannerengineering.com.

| Supply Wiring (AWG) | Required Overcurrent Protection (Amps) |
|---------------------|--|
| 20 | 5.0 |
| 22 | 3.0 |
| 24 | 2.0 |
| 26 | 1.0 |
| 28 | 0.8 |
| 30 | 0.5 |

Approvals

| Models with 2 m ITC-ER cable and unterminated tinned leads: | Models with 400 mm ITC-ER cable and a 3-pin 7/8 Minifast male quick disconnect (QD) |
|---|---|
| <p>NEC and CEC: -40°C ≤ T_a ≤ +60°C Gas & Vapors: Class I Zone 2 IIC T4 / Class I Div 2 Groups ABCD T4 Dust: Class II Zone 22 IIIC T100°C / Class II Div 2 Groups FG T5 Fibers: Class III Div 1 and Div 2 T5</p> <p>ATEX/IECEX: -40°C ≤ T_a ≤ +50°C Gas & Vapors: II 3 G Ex ec IIC T4 Gc (Group IIC Zone 2) Dust: II 3 D Ex tc IIIC T85°C Dc (Group IIIC Zone 22)</p> | <p>NEC and CEC: -40°C ≤ T_a ≤ +60°C Gas & Vapors: Class I Zone 2 IIC T4 / Class I Div 2 Groups ABCD T4</p> <p>ATEX/IECEX: -40°C ≤ T_a ≤ +50°C Gas & Vapors: II 3 G Ex ec IIC T4 Gc (Group IIC Zone 2)</p> |



UL/cULus E467619



IECEX UL 18.0115X : DEMKO 18 ATEX 2122X

Light Characteristics – Single Color Models

Cool White Efficacy: 118 lumens/Watt typical at 24 V DC at 25 °C (77 °F)
 CRI: 85, typical

| Color | Dominant Wavelength (nm) or Color Temperature | Lighted Length Lumens (Typical at 25 °C) | | | | | | | |
|------------|---|--|--------|--------|--------|--------|--------|--------|---------|
| | | 145 mm | 285 mm | 430 mm | 570 mm | 710 mm | 850 mm | 990 mm | 1130 mm |
| Cool White | 6500 K (+ 600 K/- 500 K) | 425 | 850 | 1275 | 1700 | 2125 | 2550 | 2975 | 3400 |
| Warm White | 3000 K (+ 250 K/- 150 K) | 425 | 850 | 1275 | 1700 | 2125 | 2550 | 2975 | 3400 |
| Green | 525 nm | 205 | 410 | 615 | 820 | 1025 | 1230 | 1435 | 1640 |
| Red | 618 nm | 65 | 130 | 195 | 260 | 325 | 390 | 455 | 520 |
| Yellow | 590 nm | 55 | 110 | 165 | 220 | 275 | 330 | 385 | 440 |
| Blue | 460 nm | 45 | 90 | 135 | 180 | 225 | 270 | 315 | 360 |

Light Characteristics – Dual Color Models

Daylight White Efficacy: 76 lumens/Watt typical at 24 V DC at 25 °C (77 °F)
 CRI: 83, typical

| Color | Dominant Wavelength (nm) or Color Temperature | Lighted Length Lumens (Typical at 25 °C) | | | | | | | |
|----------------|---|--|--------|--------|--------|--------|--------|--------|---------|
| | | 145 mm | 285 mm | 430 mm | 570 mm | 710 mm | 850 mm | 990 mm | 1130 mm |
| Daylight White | 5000 K (± 300 K) | 275 | 550 | 825 | 1100 | 1375 | 1650 | 1925 | 2200 |
| Green | 525 nm | 175 | 350 | 525 | 700 | 875 | 1050 | 1225 | 1400 |
| Red | 625 nm | 115 | 230 | 345 | 460 | 575 | 690 | 805 | 920 |
| Yellow | 590 nm | 85 | 170 | 255 | 340 | 425 | 510 | 595 | 680 |
| Blue | 470 nm | 65 | 130 | 195 | 260 | 325 | 390 | 455 | 520 |

Dimensions

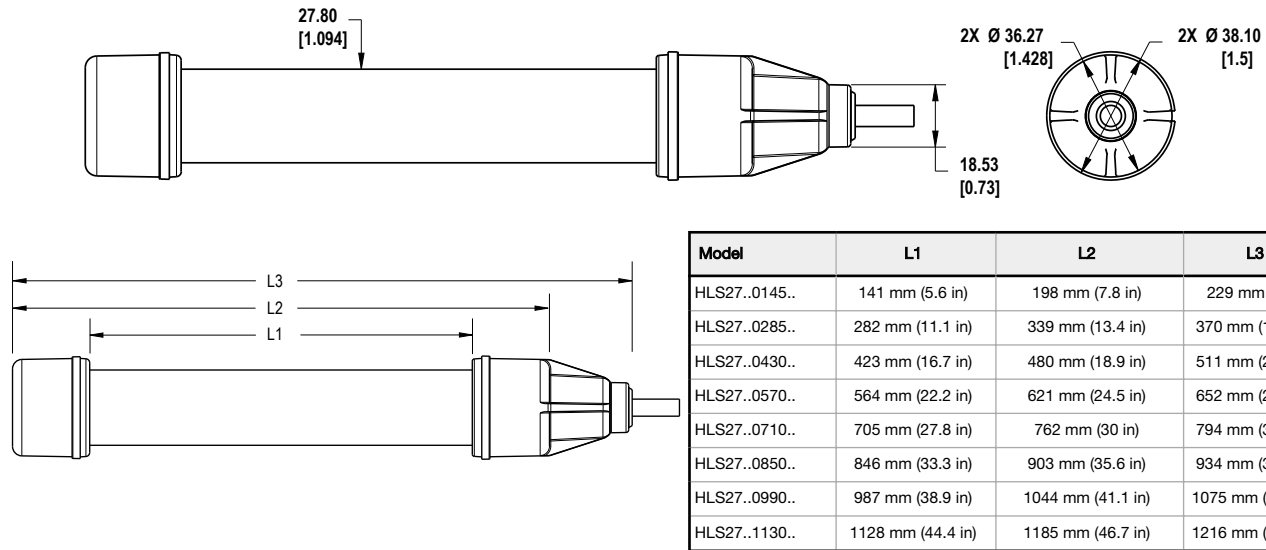

Performance

The optical data shown below is for standard single color, cool white only. To calculate lux and candela values for other colors in both the single and dual color versions, multiply the values shown on the charts by the following factors.

| Color for Single Color Models | Multiplier | Color for Dual Color Models | Multiplier |
|-------------------------------|------------|-----------------------------|------------|
| Warm white | 1 | Daylight white | 0.647 |
| Green | 0.482 | Green | 0.412 |
| Red | 0.153 | Red | 0.271 |
| Yellow | 0.129 | Yellow | 0.200 |
| Blue | 0.106 | Blue | 0.153 |

Figure 3. 145 mm Models

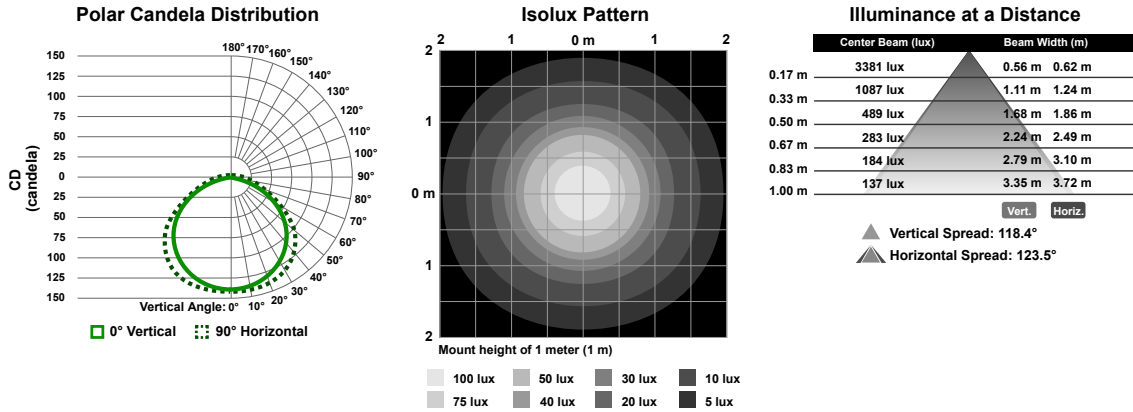

Figure 4. 285 mm Models

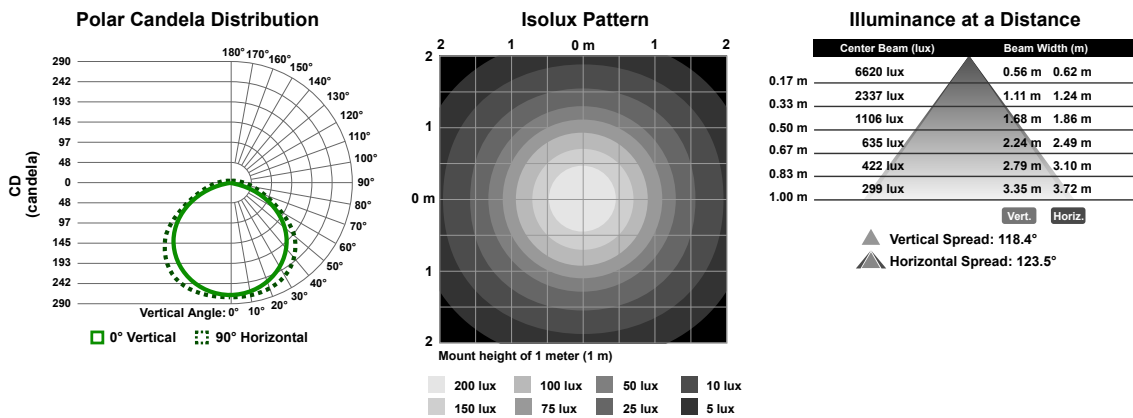

Figure 5. 430 mm Models

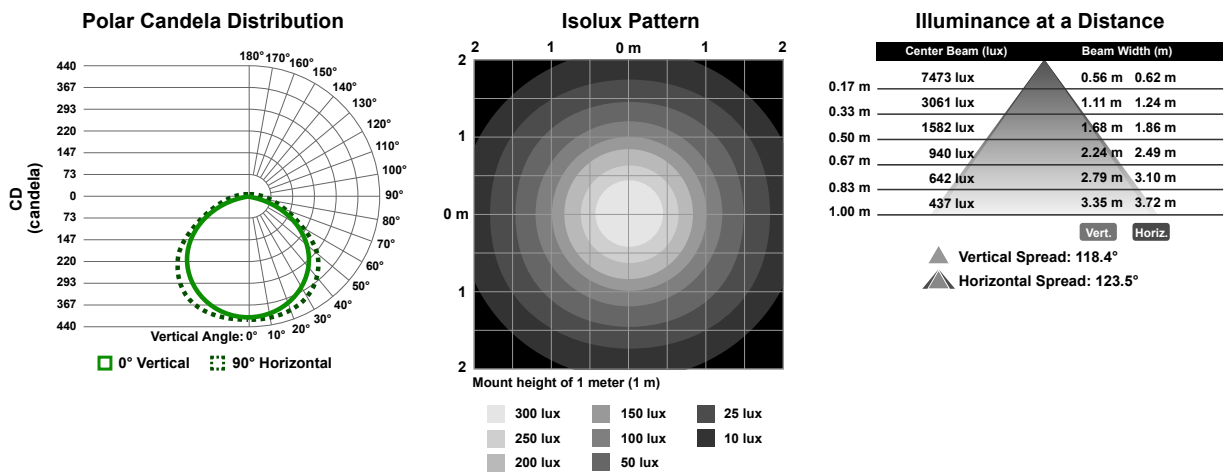

Figure 6. 570 mm Models

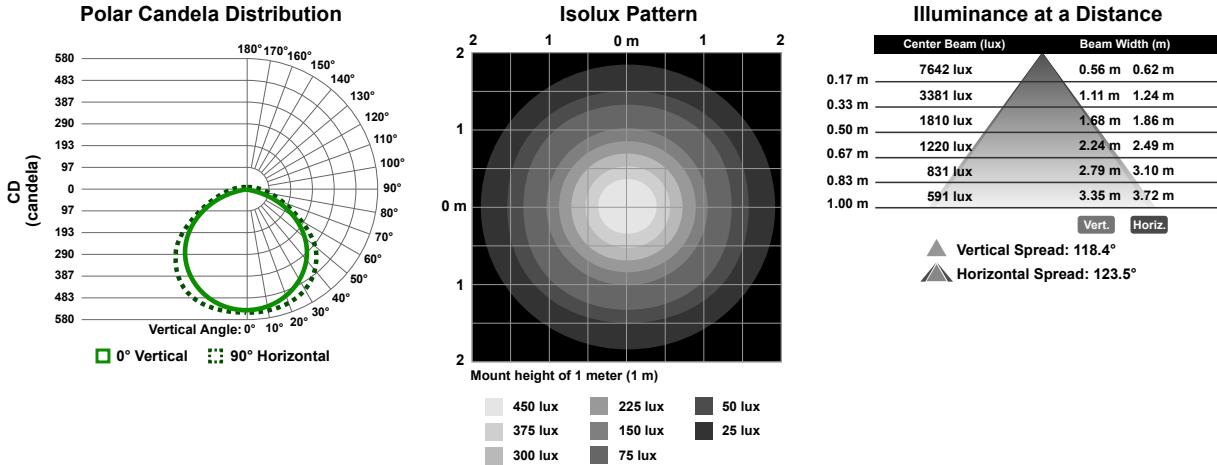

Figure 7. 710 mm Models

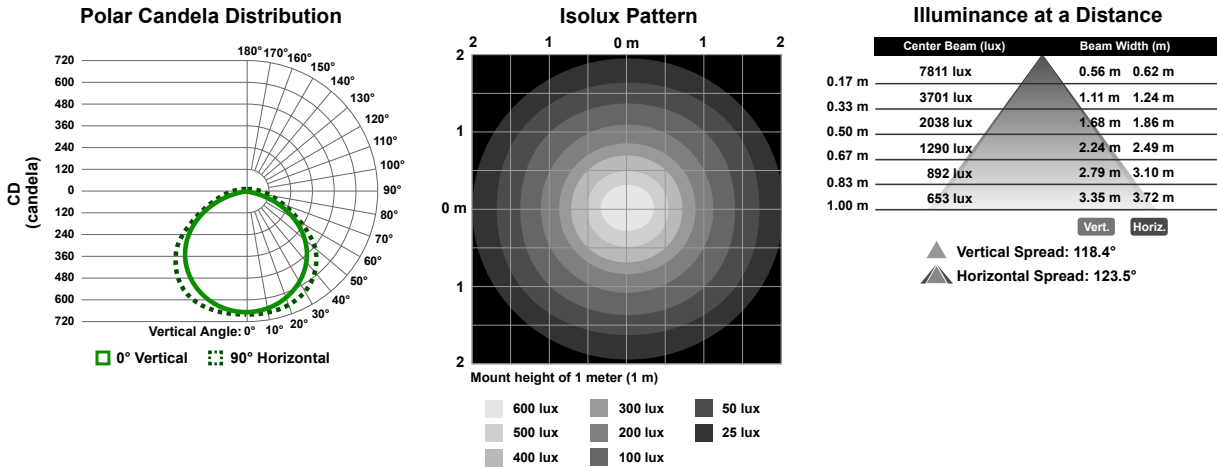

Figure 8. 850 mm Models

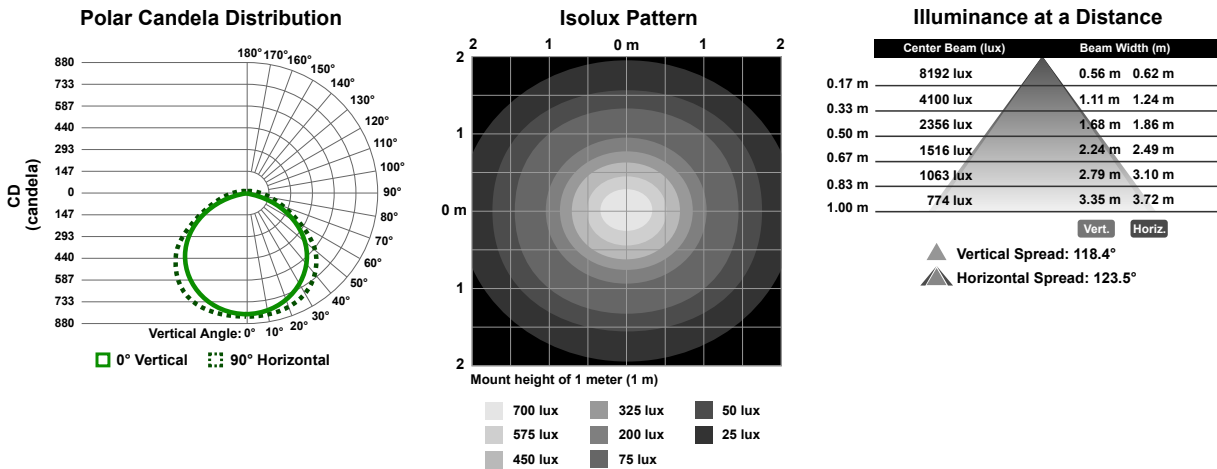

Figure 9. 990 mm Models

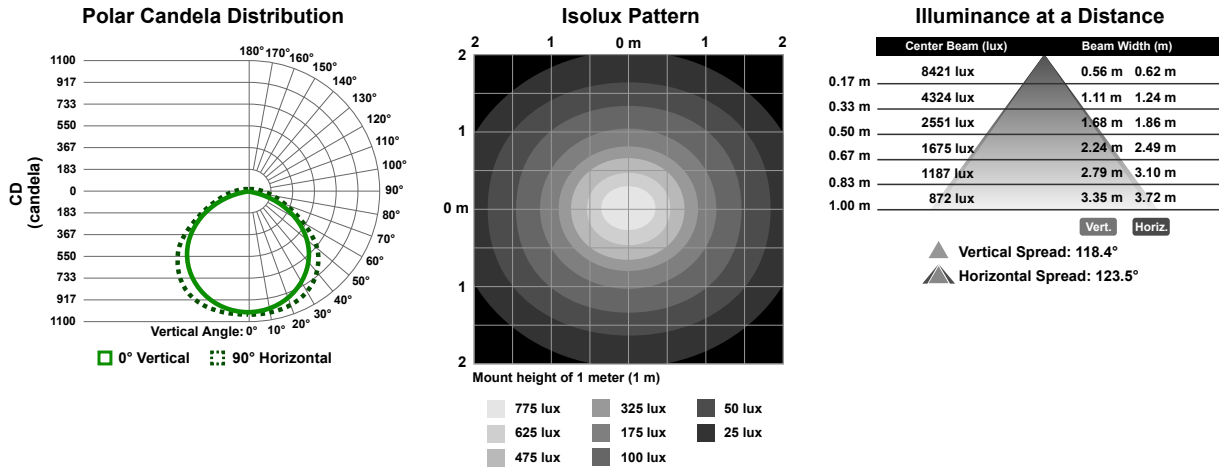
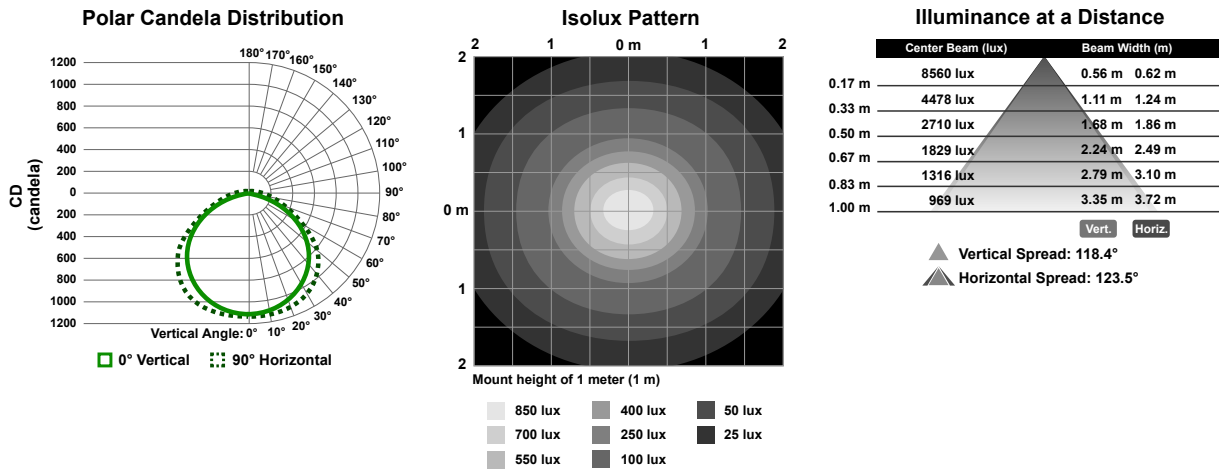

Figure 10. 1130 mm Models



Accessories

Brackets

The following brackets can be used with the HLS27 Hazardous Location LED Strip Light.

LMBHLS27S

- Set of 2 brackets
- Impact absorbing
- 300 series stainless steel
- Clearance for M5 or #10 hardware

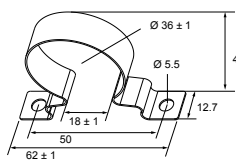

LMBHLS27O

- Set of 2 brackets
- Impact absorbing clamp
- 300 series stainless steel
- M5 stainless steel hardware included

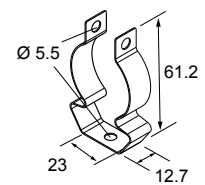

The following brackets can be used with the HLS27 Hazardous Location LED Strip Light for North America applications, but will not meet the required specifications for ATEX/IECEx.

LMBWLS27H

- 300 series stainless steel mounting brackets
- M4 stainless steel hardware included

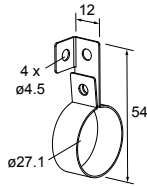

LMBWLS27U

- Clear copolyester
- Clearance for M5 or #10 hardware
- Clamps securely around the light body

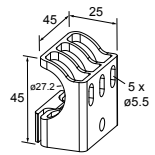

All measurements are listed in millimeters, unless noted otherwise.

Cordsets

| 3-Pin Threaded 7/8 Minifast Cordsets with ITC-ER Cable-Singled Ended | | | | | |
|--|-----------------------|--------|----------|------------|--|
| Model | Turck Part | Length | Style | Dimensions | Pinout (Female) |
| HLDMN-316 | P-X-RKVZ 32-1699XL-5M | 5 m | Straight | | <p>1 = Blue (bu) 2 = Brown (bn) 3 = Black (bk)</p> |
| HLDMN-330 | P-X-RKVZ 32-1699XL-9M | 9 m | | | |

| Model | Description |
|--------------|---|
| HFDMN-LOCK | Locking device for the HLDMN cordsets, qty 1 |
| HFDMN-LOCK10 | Locking device for the HLDMN cordsets, qty 10 |

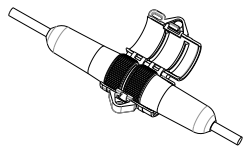

A locking device is included with every QP model. See Turck file number 100013548 for installation instructions.

Banner Engineering Corp. Limited Warranty

Banner Engineering Corp. warrants its products to be free from defects in material and workmanship for one year following the date of shipment. Banner Engineering Corp. will repair or replace, free of charge, any product of its manufacture which, at the time it is returned to the factory, is found to have been defective during the warranty period. This warranty does not cover damage or liability for misuse, abuse, or the improper application or installation of the Banner product.

THIS LIMITED WARRANTY IS EXCLUSIVE AND IN LIEU OF ALL OTHER WARRANTIES WHETHER EXPRESS OR IMPLIED (INCLUDING, WITHOUT LIMITATION, ANY WARRANTY OF MERCHANTABILITY OR FITNESS FOR A PARTICULAR PURPOSE), AND WHETHER ARISING UNDER COURSE OF PERFORMANCE, COURSE OF DEALING OR TRADE USAGE.

This Warranty is exclusive and limited to repair or, at the discretion of Banner Engineering Corp., replacement. **IN NO EVENT SHALL BANNER ENGINEERING CORP. BE LIABLE TO BUYER OR ANY OTHER PERSON OR ENTITY FOR ANY EXTRA COSTS, EXPENSES, LOSSES, LOSS OF PROFITS, OR ANY INCIDENTAL, CONSEQUENTIAL OR SPECIAL DAMAGES RESULTING FROM ANY PRODUCT DEFECT OR FROM THE USE OR INABILITY TO USE THE PRODUCT, WHETHER ARISING IN CONTRACT OR WARRANTY, STATUTE, TORT, STRICT LIABILITY, NEGLIGENCE, OR OTHERWISE.**

Banner Engineering Corp. reserves the right to change, modify or improve the design of the product without assuming any obligations or liabilities relating to any product previously manufactured by Banner Engineering Corp. Any misuse, abuse, or improper application or installation of this product or use of the product for personal protection applications when the product is identified as not intended for such purposes will void the product warranty. Any modifications to this product without prior express approval by Banner Engineering Corp will void the product warranties. All specifications published in this document are subject to change; Banner reserves the right to modify product specifications or update documentation at any time. Specifications and product information in English supersede that which is provided in any other language. For the most recent version of any documentation, refer to: www.bannerengineering.com.

For patent information, see www.bannerengineering.com/patents.

Repairs

Contact Banner Engineering for troubleshooting of this device. **Do not attempt any repairs to this Banner device; it contains no field-replaceable parts or components.** If the device, device part, or device component is determined to be defective by a Banner Applications Engineer, they will advise you of Banner's RMA (Return Merchandise Authorization) procedure.



Important: If instructed to return the device, pack it with care. Damage that occurs in return shipping is not covered by warranty.

FCC Part 15 and CAN ICES-3 (B)/NMB-3(B)

This device complies with part 15 of the FCC Rules and CAN ICES-3 (B)/NMB-3(B). Operation is subject to the following two conditions:

1. This device may not cause harmful interference, and
2. This device must accept any interference received, including interference that may cause undesired operation.

This equipment has been tested and found to comply with the limits for a Class B digital device, pursuant to part 15 of the FCC Rules and CAN ICES-3 (B)/NMB-3(B). These limits are designed to provide reasonable protection against harmful interference in a residential installation. This equipment generates, uses and can radiate radio frequency energy and, if not installed and used in accordance with the instructions, may cause harmful interference to radio communications. However, there is no guarantee that interference will not occur in a particular installation. If this equipment does cause harmful interference to radio or television reception, which can be determined by turning the equipment off and on, the user is encouraged to try to correct the interference by one or more of the following measures:

- Reorient or relocate the receiving antenna.
- Increase the separation between the equipment and receiver.
- Connect the equipment into an outlet on a circuit different from that to which the receiver is connected.
- Consult the manufacturer.



more sensors, more solutions